

Remote Status Unit • Installation Instructions



THIS EQUIPMENT MUST ONLY BE INSTALLED BY A SUITABLY SKILLED AND TECHNICALLY COMPETENT PERSON. ENSURE THE UNIT IS ELECTRICALLY ISOLATED PRIOR TO INSTALLATION/MAINTENANCE.

GENERAL

The Remote Status Unit (RSU) connects to the EP203 Automatic Extinguisher panel and provides remote system status indication, an LCD status display unit, manual release of extinguishant, an extinguishant mode keyswitch and three monitored inputs. RSUs can be either flush-mounted (Part No. EP210F), or surface-mounted (Part No. EP210S).

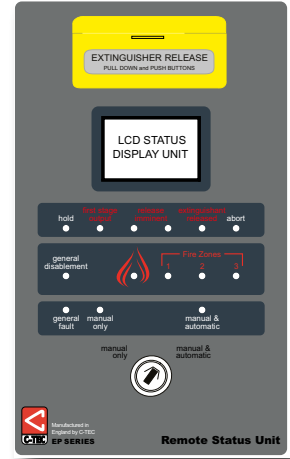

INSTALLATION

Location

The RSU must be sited indoors on a dry, flat surface in an area that is well ventilated. Ideally the LED indicators and LCD should be at eye level and the ambient light level should allow the status of indicators to be clearly seen.

Fixing

Take the RSU out of its packing box. Using the Allen key (supplied in the accessory pack) remove the RSU's front lid by undoing the four lid screws.

Note: If required, to protect the electronics from damage, the Connector PCB (mounted in the RSU base) can be removed prior to first fix installation. Simply unscrew its one retaining screw and slide the PCB off its four mounting pillars. Disconnect the telecoms-style connecting cable from PL1 on the PCB.

Fix the RSU's base securely onto a wall using the four mounting holes provided. Assess the condition and construction of the wall and use suitable screw fixings. Any dust or swarf created during the fixing process must be kept out of the RSU and care must be taken not to damage any wiring or components.

Wiring and Cable Entry

All wiring should be installed in accordance with the current edition of the IEE Wiring Regs (BS7671), or the relevant national standards.

Cables should be fed into the RSU via the knockouts provided on the top of the base unit. Knockouts should be removed with a sharp, light tap using a flat 6mm broadsided screwdriver as shown in diagram (see right). Always ensure that if a knockout is removed, the hole is filled with a good quality 20mm cable gland. Any unused knockouts must be securely blanked off.

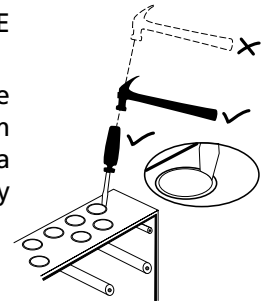

EP203 Automatic Extinguisher Panel

Fig.1 - Typical RSU Circuit Wiring (Total wiring length < 30metres)

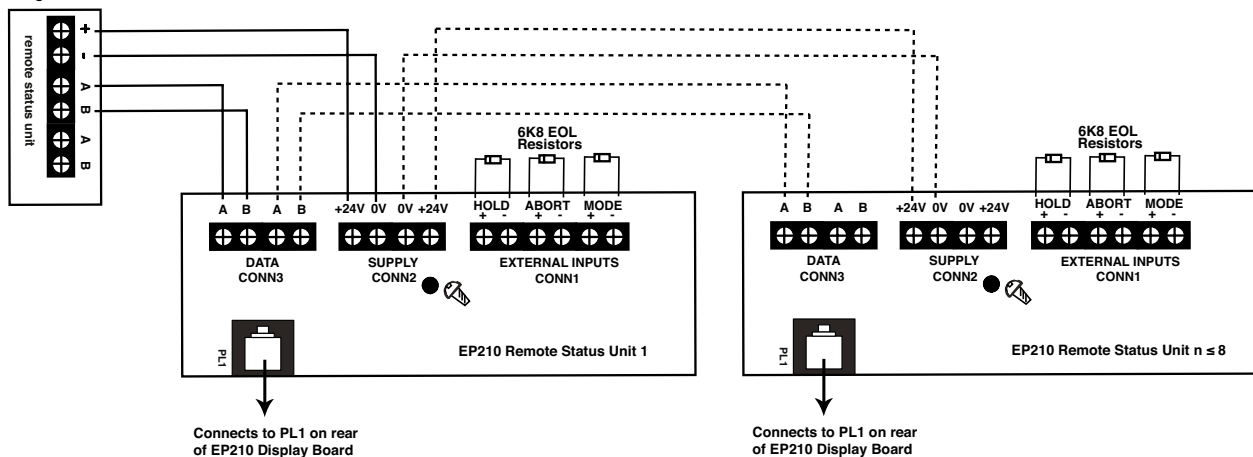

The first RSU connects to the connector block on the Main Control PCB (mounted inside the EP203 panel) via a 4-wire connection (2-wire power, 2-wire RS485). The wiring is then daisy-chained to the remaining RSUs (see Fig.1). A maximum of eight RSUs can be connected. Total wiring length < 30 metres.

Three monitored input connections are available at the RSU: Hold, Abort, and Mode. A 6k8 EOL resistor (supplied in the accessory pack) must be connected across the terminals of the last device on each monitored circuit to allow the wiring to be line monitored for open and short circuit faults (see Fig.2). Unused circuits must have a 6k8 resistor fitted at CONN1 on the Connector PCB.

The RSU also has a Display Board which has a pcb-mounted LCD status display unit, DIL switch and Display Contrast (VR1). Adjust (VR1) to suit the contrast of the unit's LCD display.

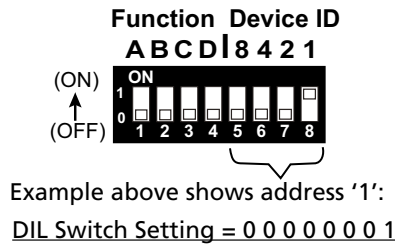
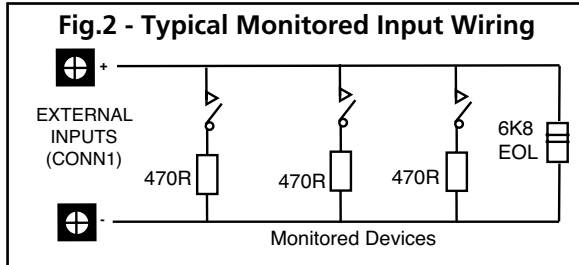

RSU ADDRESS	DIL SWITCH			
	5	6	7	8
1	0	0	0	1
2	0	0	1	0
3	0	0	1	1
4	0	1	0	0
5	0	1	0	1
6	0	1	1	0
7	0	1	1	1
8	1	0	0	0

DIL Switch Operation

Each RSU must be allocated a unique address between 1 and 8 by setting the DIL switch. See above for switch settings. Set each address using Device ID bits 5 to 8. DIL switch up (ON) = 1, DIP switch down (OFF) = 0. **Note:** Function bits A to D are for future use and non-functional.

CONTROLS & INDICATORS

The front of the RSU has various indicators, controls and an LCD status display unit, as detailed below:

LED Indicators

(General Fire); Fire Zones (x3); General Disablement; Hold; First Stage Output; Release Imminent (x2); Extinguishant Released; Abort; General Fault; Manual Only; Manual & Automatic.

LCD Status Display Unit

Provides system status information and displays the countdown time before extinguishant is released.

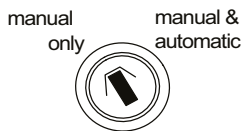
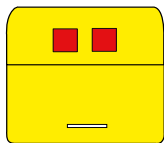

Pushbutton Controls

Extinguisher Release (housed in yellow plastic casing).

CAUTION: THESE PUSHBUTTONS MANUALLY RELEASE THE EXTINGUISHANT.

Pull down the plastic flap and press both red buttons simultaneously to release the extinguishant.

Keyswitch Controls

Insert the key and turn the keyswitch to toggle the mode of the extinguishant system between "Manual Only" and "Manual & Automatic".

NOTE: WHEN THE RSU IS IN "MANUAL ONLY" MODE, THE MAIN EP203 PANEL ALSO REVERTS TO MANUAL MODE AND EXTINGUISHANT CANNOT BE RELEASED BY AUTOMATIC FIRE DETECTION.

TECHNICAL SPECIFICATION

Remote Status Unit (RSU)	Part No. EP210S (surface)/EP210F (flush)
Connections:	1st RSU (Data A & B) to Panel (RSU A & B); 1st RSU (Supply 24V & +0V) to Panel (RSU + & -). 1st RSU (Data A & B) to next RSU (Data A & B); 1st RSU (Supply 0V & +24V) to next RSU (Supply 0V & +24V).
Power:	21-28Vdc, 200mA electronic fuse
Max. number of RSUs per EP203:	Eight (8). Total wiring length < 30 metres.
Number of monitored inputs:	3 (Hold, Abort, Mode)
Dimensions of EP210S:	160mm(w) x 240mm(h) x 51mm(d) approx. (metal)
Dimensions of EP210F:	175mm(w) x 250mm(h) x 53mm(d) approx. (metal)
Accessory Pack	
1 x Installation Instructions – Document No. DFU0000210 (this document); 1 x Allen key; 3 x 6.8K 0.25W EOL resistors; 2 x keys (for the extinguishant mode keyswitch).	



E&OE. No responsibility can be accepted by the manufacturer or distributors of the extinguisher panel ancillaries for any misinterpretation of this instruction, or for the compliance of the system as a whole. The manufacturer's policy is one of continuous improvement and we reserve the right to make changes to product specifications at our discretion and without prior notice. www.c-tec.com